

 Cricchi a grande alzata

 High lift jacks

 Hochheber

 Crics à grande levée

 Gatos de gran elevación



 Manico ergonomico per il comfort dell'utilizzatore. Ricoperto in gomma • Il sistema di discesa "solleva e gira" previene abbassamenti non intenzionali • Il pedale a piede addizionale permette un sollevamento veloce della sella • Valvola di controllo abbassamento per una discesa sicura perfino con il massimo carico • Finitura a polvere. Struttura completamente saldata in acciaio di alta qualità • Ruote a diametro largo per movimentazione facile.

 Ergonomically designed handle for operator comfort. Rubber coated • "Lift-and-turn" lowering system prevents unintentional lowering • Additional foot pedal pumping feature provides fast saddle raising to the load • Safety lowering control nylon wheels.valve for safe lowering even under maximum load • Powder coated finish. Heavy duty fully welded structure in high quality steel • Large diameter swivel wheels for easy handling.

 Ergonomisch geformte gummiüberzogene Griffe für besseren Bedienkomfort • Heben und Drehen, Absenksystem schützt gegen unbeabsichtigtes Absacken von Lasten • Zusätzliches Fußpedal zum schnellen Hochfahren des Sattels (Schnellhub) • Ein Sicherheitsventil zur Steuerung des Absenkvorganges gewährleistet das Ablassen von Lasten mit definierter • Geschwindigkeit und schützt gegen unbeabsichtigtes Absacken von Lasten auch unter max. Traglast • Pulverbeschichtet. Robuste, voll verschweißte Stahlkonstruktion aus höchster Stahlqualität • Grosse Schwenkrollen für Stabilität und Wendigkeit unter Last.

 Poignée de conception ergonomique pour un grand confort d'utilisation. Revêtement de caoutchouc • "Dispositif de descente "levage et blocage" empêchant toute descente intempestive • La pédale additionnelle de pompage assure unlevage rapide du sabot d'appui vers la charge • Vanne-pilote de sécurité pour une descente sûre, même sous la charge maximale • Finition: peinture par poudrage. Structure d'acier haute qualité • Roues pivotantes de grand diamètre pour manutention facile.

 Mango ergonómico para el confort del usuario. Revestido en goma • El sistema de descenso "eleva y gira" precave bajadas no intencionadas • El pedal adicional permite una elevación rápida de la silla • Válvula de control de bajada para un descenso seguro también con la carga máxima • Acabado con pintura de polvos. Estructura completamente soldada en acero de alta calidad • Ruedas de diámetro grande para un desplazamiento facilitado.



Dati tecnici	Technical data	Technische Eigenschaften	Caractéristiques techniques	Datos técnicos				
MOD.	Max (Ton)	A (mm)	B (mm)	C (mm)	D (mm)	E (mm)	F (mm)	Kg
WJH-1,5T-HC	1,5	98	800	1050	169	380	925	52
WJH-2T-HC	2	98	735	1035	210	380	1045	53
WJH-3T-HC	3	130	860	1620	210	460	1045	88
WJH-5T-HC	5	180	960	1830	350	475	1045	151
WJH-8T-HC	8	180	960	1830	350	475	1045	160
WJH-10T-HC	10	210	770	1700	290	475	1045	139

Altezza max. 960 mm.
Max. height 960 mm.
 Maximale Hubhöhe 960 mm.
 Hauteur maxi.: 960 mm.
 Altura máx. 960 mm.

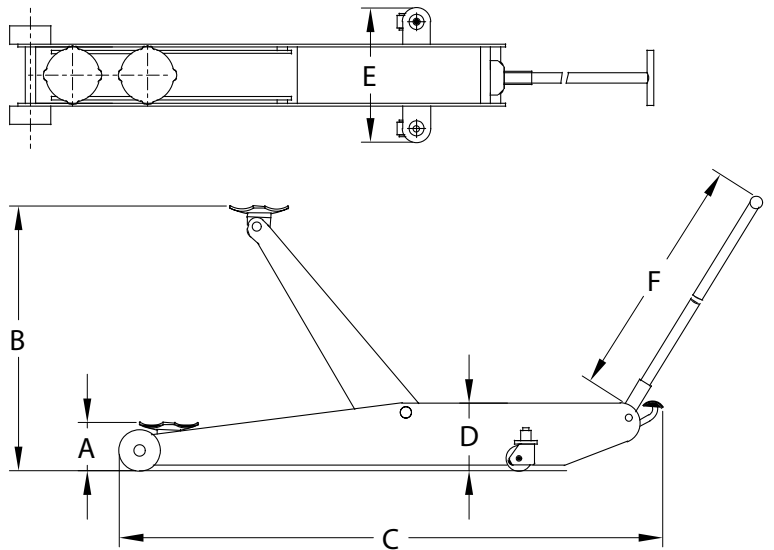

Opzioni	Optionals	Sonderzubehör	Options	Opcionales
---------	-----------	---------------	---------	------------



WJH1,5T-HC - WJH2T-HC

Il sistema boogie è ideale per le officine con pavimento non pari ed all'esterno - Rulli e ruote in poliuretano

The bogie system is ideal for workshops with uneven floors and outdoors - Polyurethane rollers and wheels

Ideal für Karosserie- und Lackierwerkstätten - Rollen und Räder aus Polyurethan

Les roues boogie sont idéales pour les ateliers aux sols inégaux et à l'extérieur des bâtiments - Rouleaux et roues en polyuréthane

El sistema de ruedas boogie es ideal para los talleres con piso irregular y al aire libre - Rodillos y ruedas de poliuretano



Ruote in gomma ad aria.

Air rubber tyres

Luftgummiräder. 5T-HC / 8T-HC / 10T-HC

Pneumatiques en caoutchouc

Ruedas neumáticas en goma



WJH1,5T-HC - WJH2T-HC

Tappo in gomma

Rubber pad

Gummiauflage

Tampon en caoutchouc

Tapón de goma